

INSTALLING
VIN₂A₁ VERRE 8.0

Connections behind the product	2
Setting up the appliance	3
Flush-fitting the appliance	3
Adjusting the feet	3
Adjusting the doors	3
Connecting the nitrogen cylinder	4
Installing the glass holders	5
Electrical connection	6
First configuration	7
Language	7
Date and time	7
Password	8
Cleaning	8
Calibration	9
Setting measures	9
Setting temperatures	10
Training	11
Description of the screen and menus	12
Installing a bottle	13
Serving a measure	15
Operating faults and warning messages	16
Maintenance procedures	17

Connections behind the product



*To be done before the product is built-in
or placed against a wall*

- ❁ **Connect the nitrogen supply pipe to the appliance**

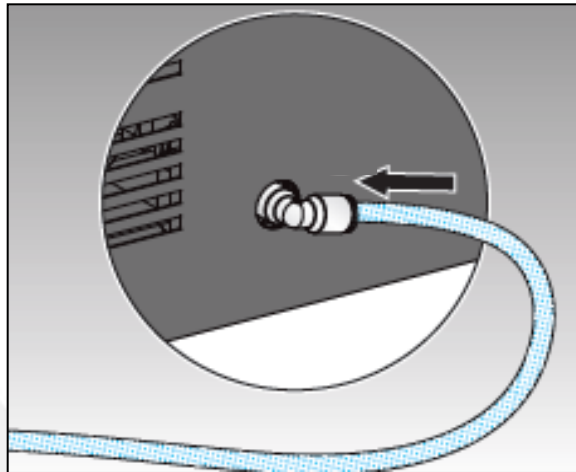

- ❁ **Connect the power cord to the VV8**

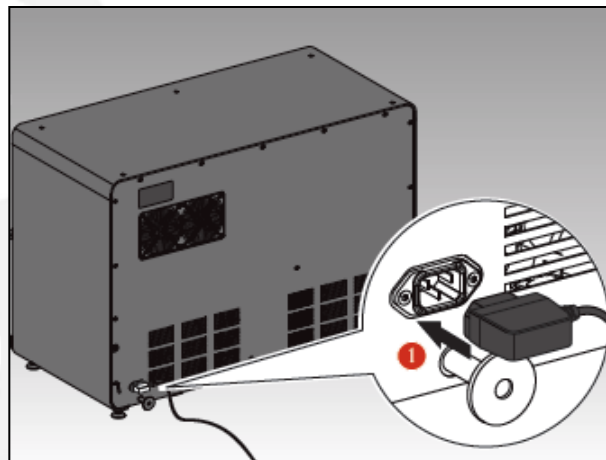

Setting up the appliance

- ❁ Observe the following flush-fitting conditions if needed

Be careful :

If those requirements are not fulfilled, it can lead to temperature defects.

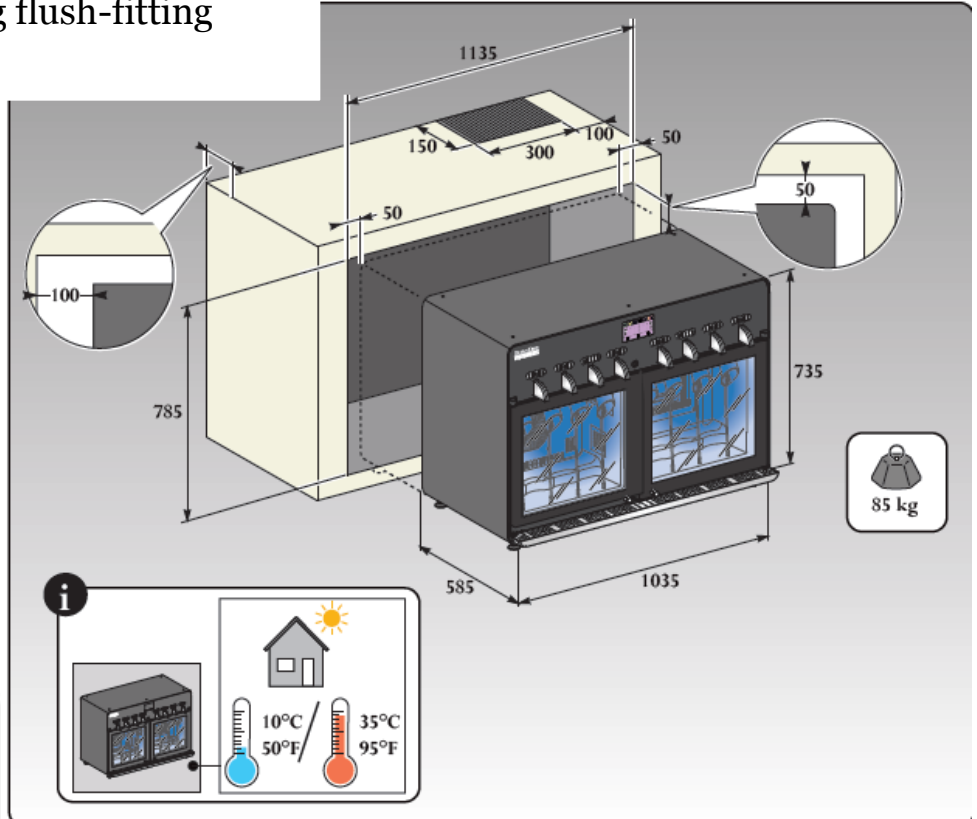

- ❁ Adjust the 4 feet independently in such a way as to incline your cabinet slightly towards the rear by 2 - 3°, in order to allow condensation to flow out.



- ❁ To perfectly align the appliance's doors horizontally and correct any unevenness of the surface on which the appliance will stand, you can tighten or loosen the front feet with a 19mm key.



19

Connecting the nitrogen cylinder

Make sure you place the nitrogen bottle in a safe place to prevent it from falling (risk of damaging the pressure regulator)

Remove the safety cap located on the tip of the nitrogen bottle (1)

Place the pressure reducer on the nitrogen cylinder and screw down using the pressure reducer wrench (2;3).

Connect the supply pipe to the pressure reducer (4)

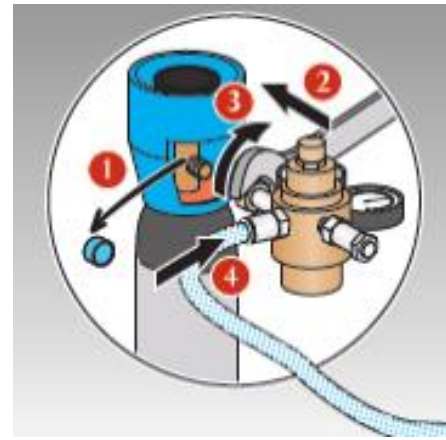

Open the nitrogen bottle
The pressure must be
0.6 bars max (6)

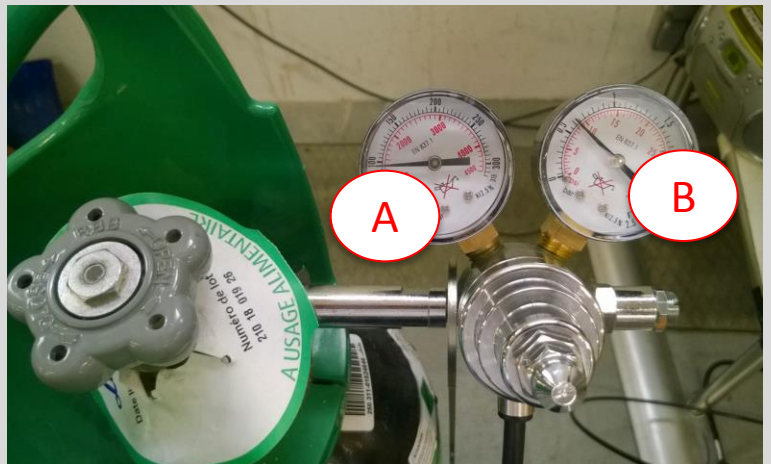
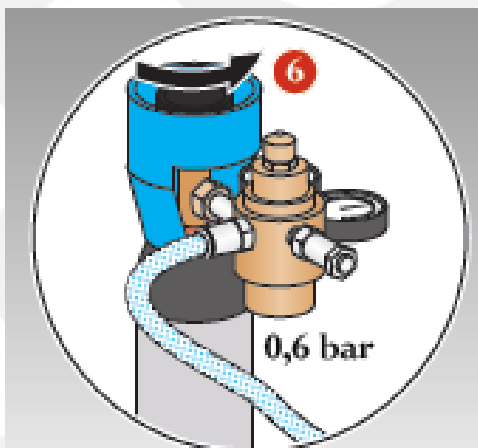

The pressure gauge (A) shows you the level of gas in the cylinder.
A full bottle = 200 bars.

The second pressure gauge (B) shows you the supply pressure of the appliance: 0.6 bar

Installing the glass holders

Using a 4mm
Allen key
(supplied)

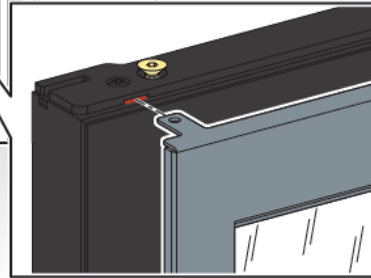
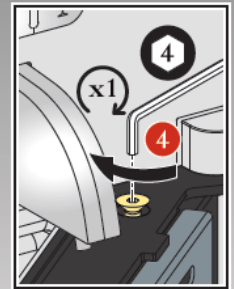
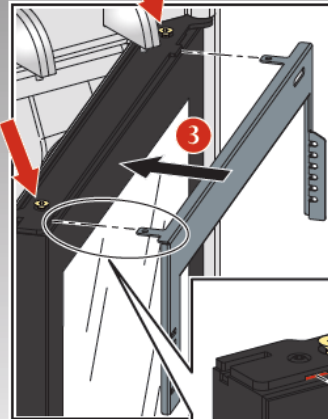
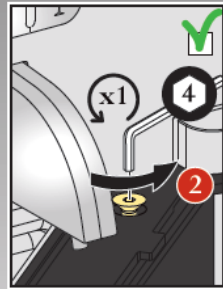
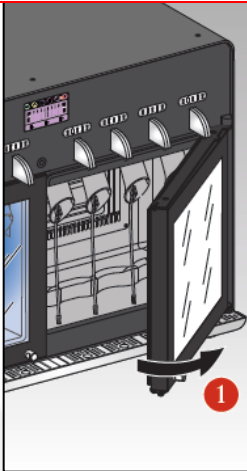

❁ Remove the protective film from **both sides** of the glass holder

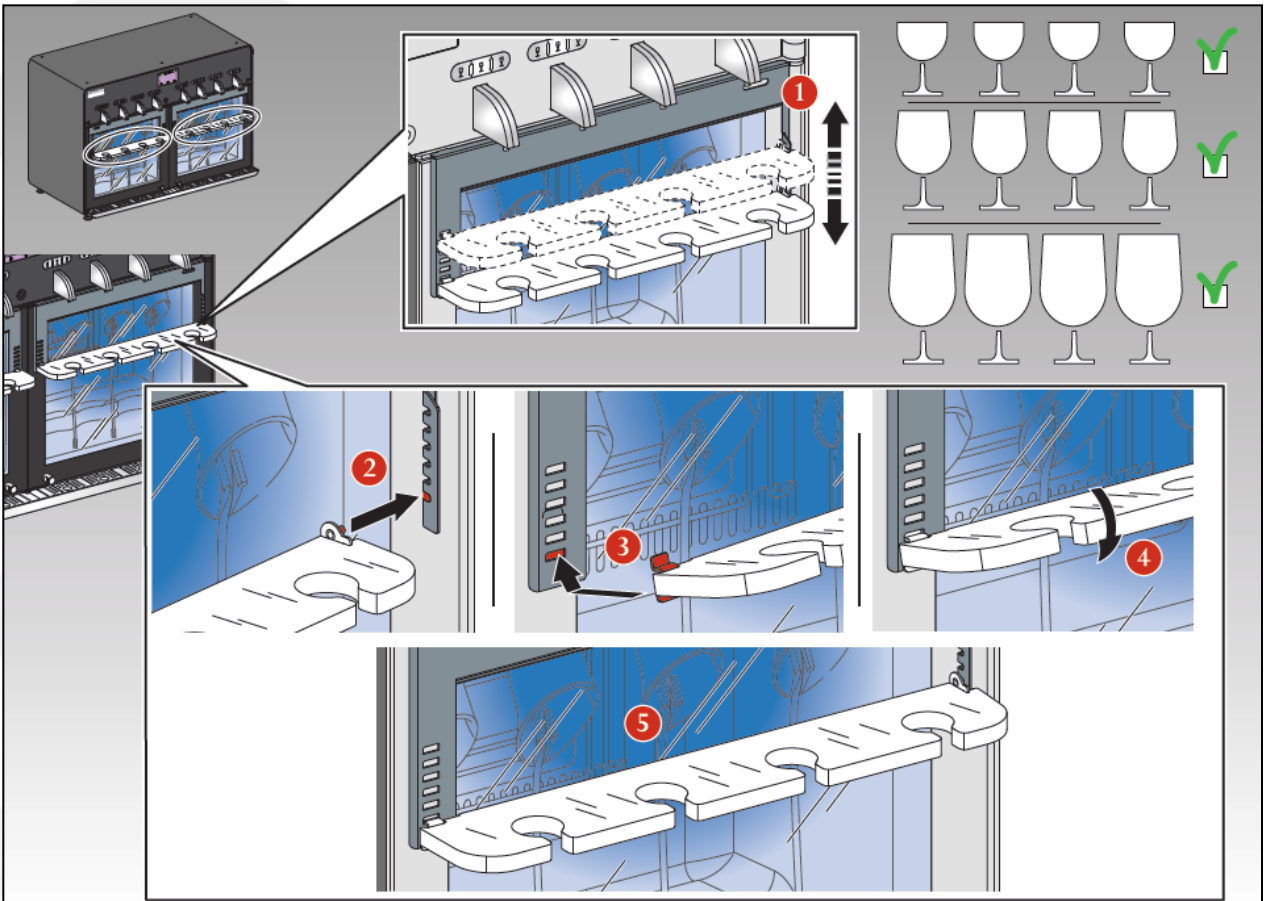

❁ Show the customer that it is possible to install or not the glass holders, and to adjust the height according to the glasses.

Electrical connection

- ❁ Plug the VV8 cord to the electrical outlet

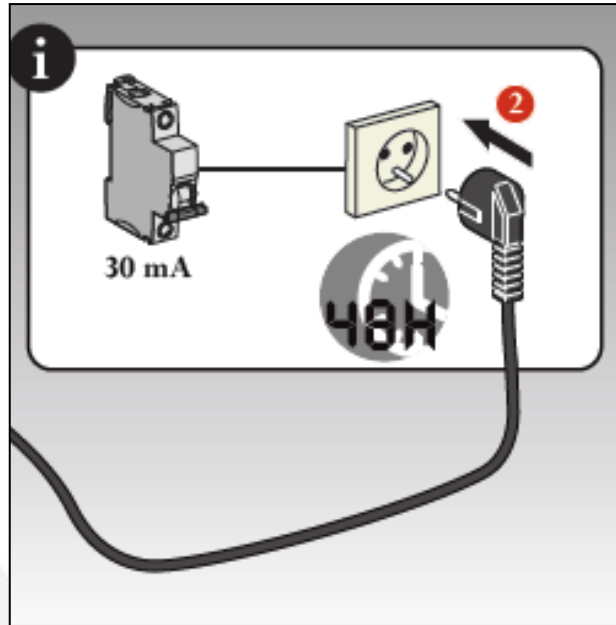

First configuration

The installation screen helps to configure the mains settings through tutorials.

We recommend doing this step in the presence of the manager .

At each step, a tutorial is associated.

Once the step is completed, a tick appears in front of the line. Once all steps have been completed, the installation is validated and the main screen will appear.

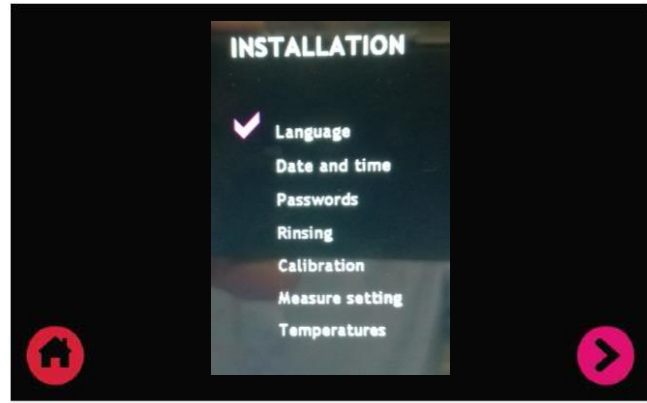

LANGUAGE, UNITS AND CURRENCY



Choose your language by using the arrows to scroll up and down the list
Then continue to the next step by pressing

Choose the temperature unit by using the arrows to scroll up and down the list

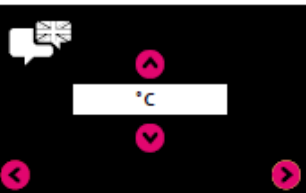

Then continue to the next step by pressing

Choose the unit of volume by using the arrows to scroll up and down the list

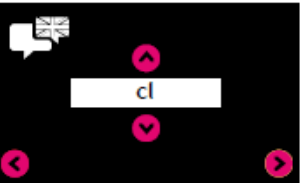

Modifying the unit of volume will reset the volume of the 24 measures by default.

Then continue to the final step by pressing

Choose your currency
To do so, click the text bar. Four currency options will appear. Delete the currency already filled in (€) by pressing the key and select your currency: €, \$, ¥, £.

If it is not on the list, press , and enter your currency manually (3 characters maximum): DIN, RMB, MXN, CHF...

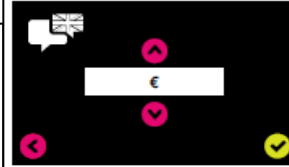

Then confirm

The currency, volume, temperature unit and language settings are finished.

DATE & TIME

Set the hours/minutes using the keyboard on the screen,

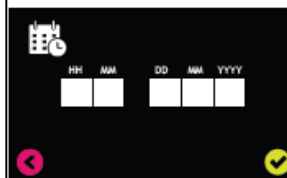

then indicate the date (day/month/year) and confirm

N.B. it is necessary to delete the existing content with the key before entering a new value.

First configuration

PASSWORD

You will be asked for the "waiter password" to **lock/unlock**  Vin au Verre 8.0.

You will be asked for the "manager password" to **lock/unlock**  and access the **Settings menu** .



Ask the Manager what passwords he wants to set for the waiter and manager.

Initially, the waiter and Manager passwords are: **0000**



Tip: it is possible to have one single password to manage all functions.

To do so, simply enter the same password for Manager and Waiter.

CLEANING

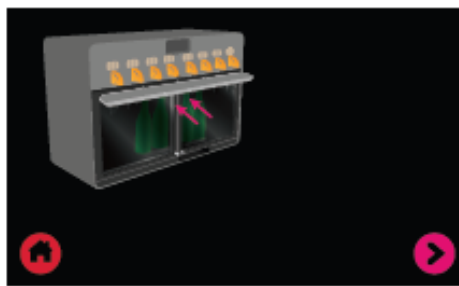

Place the drip pan in the upper position.

To do so, lift and tilt the drip pan upwards to remove it, and place it in the upper position by following the instructions on the screen.

The tabs of the drip tray must fit into the slots

located above the doors so that the drip pan is pushed against the doors to the maximum.

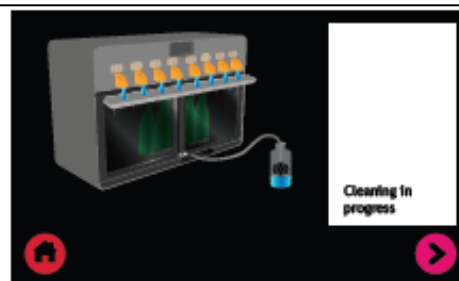

Retrieve the cleaning tube from the hole located at the back of the drip tray, when this is in the lower position.

Insert this tube into the cleaning bottle filled with clean water.

Confirm  when this is done.

Cleaning is carried out automatically.

Once completed, empty the contents of the drip pan into a sink, put the tube in its original location and replace the drip pan by tilting it forwards.

First configuration

CALIBRATION

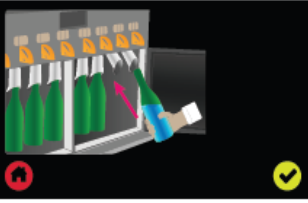

Install a wine bottle filled with water in any of the bottle holders, ensuring that you insert the tube into the bottle.

To do so, push the bottle upwards, then forwards whilst maintaining it in the upper position.

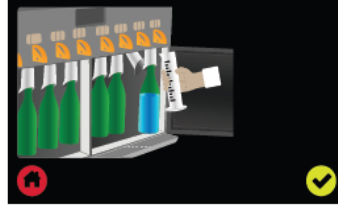

Place the measuring cylinder under the tap.

Press one of the 3 tap measures of the bottle of water installed earlier

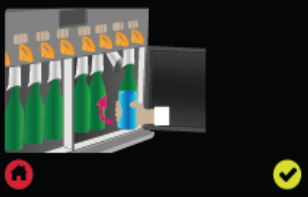

Look at the volume shown on the measuring cylinder and enter the volume served in millilitres on the screen.

Then confirm .

Remove the bottle of water from the appliance.

Calibration is finished.

There is no need to repeat the process for the other taps, one calibration is enough.

SETTING MEASURES

Ask the Manager what measures he wants to set.



Select the bottle(s) for which you want to set the measures.



This indicator light indicates that the bottle has been selected. Press the indicator light to deselect it.

Then confirm .





3 measures can be set for each of the 8 taps. Indicate the amount in centilitres or ounces and the price per glass for each of the measures.

Then confirm .

 **Tip** : if you want the 3 measures of the 8 taps to all have identical settings (example: 3, 6 12 cl for the 3 measures of all 8 taps), tick  to set them all in one go.

 **Tips** :

- The volumes of the measures to be entered must be between 1 cl (1 oz) and the total volume of the bottle inserted.
- Delete the content of the cell by pressing  before entering the value.
- For the price of the glass, it is necessary to enter the values decimally. Example for €5: enter 5-0-0
- By indicating the price of the glass, you can find out how much wine has been consumed and the turnover generated by the label in the **Statistics Menu** 

First configuration

SETTING TEMPERATURES

Ask the Manager what temperatures he wants to get for each compartment

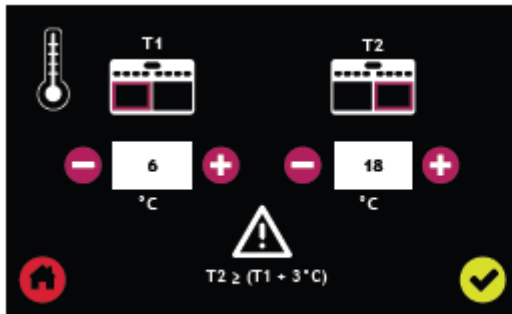

Set the temperatures in the two compartments using Δ and $+$ and $-$

Then confirm

Important : Ensure that the temperature in compartment 2 (right-hand compartment) is higher by 3° C (5 °F) than that of compartment 1 (left-hand compartment)

The recommended temperature ranges are:

- Left-hand compartment: 6 - 15°C / 43-59°F
- Right-hand compartment: 9 - 18°C / 48-64°F

The start up is now complete.
Start the user training.











Training – Features overview

❁ Explain the main screen

ACTIONS POSSIBLE FROM THE WELCOME SCREEN



	<p>To lock / unlock</p> <p>You will be asked for your "manager" or "waiter" password.</p> <ul style="list-style-type: none"> • The key picture is red: <p>Vin au Verre 8.0 is locked, the taps are closed – no drinks can be served</p> <ul style="list-style-type: none"> • The key picture is green: the Vin au Verre 8.0 is in operation
	<p>To switch the lights on/off for the entire product (taps and compartments)</p>
	<p>Shortcut to Daily cleaning menu. This indicator light will flash to remind you to carry out cleaning</p>
	<p>Shortcut to Bottle changing menu for a bottle of the same label</p>
	<p>Access to Settings menu.</p> <p>You will be asked for the "manager access" password</p>

	<p>Other information</p> <ul style="list-style-type: none"> • The indicator light will flash to tell you to check the nitrogen level • To obtain the instructions, send an email to the address shown on this menu. A link will be sent to you so that you can obtain the instructions in electronic format
<p>6°C/18°C</p>	<p>°C: Displays the temperature setting in both compartments. Can also be set in Fahrenheit</p>
	<p>Displays the level of wine remaining in each bottle in real time</p>
	<p>Displays the measure if all set measures are identical for all 8 bottles.</p> <p>If the 8 bottles all have different settings, the measures will be shown below each of the bottles (the smallest measure at the top, the largest measure at the bottom)</p>

By default, the screen goes into standby mode after 30 seconds of inactivity.





To exit standby mode, touch the surface of the screen.





Training – Features overview

❁ Explain the other menus by navigating in each pictogram.





Insist on the difference between changing a bottle by the same reference and by a different reference.





ACTIONS POSSIBLE FROM SCREEN 1 OF THE SETTINGS MENU

	To configure the bottles in use (name of the label & volume of the bottle) or to change a bottle for another label
	Setting the volume of the 3 measures by tap and the price by measure
	Setting the temperatures of both compartments
	Choice of lighting in the compartments and on taps: selection of colours and light intensity
	Changing to Manual mode - The warnings will be disabled. N.B.: if there is a leak, you will not be informed of it. - The statistics function and measure control will be disabled: it will then be necessary to press and hold down the button to obtain the desired measure

	Launch of daily cleaning
	Calibrating the appliance when using for the first time. This procedure can also be repeated if the appliance needs to be moved or if there is a problem with measure accuracy.
	Statistics: to consult turnover and volumes served per label for a given period
	Access to the second screen of the Parameters menu
	Return to the welcome screen

ACTIONS POSSIBLE FROM SCREEN 2 OF THE SETTINGS MENU

	Changing your “manager” and/or “waiter” password
	Configuring the date and time
	If you are connecting Vin au Verre 8.0 to your cash desk. To do so, you must follow a protocol. Contact the retailer from whom you bought the appliance
	Return to factory settings: all your settings will be deleted, the appliance is reset
	To define: <ul style="list-style-type: none"> • The language • The unit of volume (centilitre, ounce) • The currency • The unit of temperature (Degree Celsius, Fahrenheit)

	Changing to “Self-Service” mode with the card reader, separate from the machine. For this configuration, contact the retailer from whom you bought the appliance.
	Return to screen 1 of the Settings menu
	Return to the welcome screen
	Allows you to choose either a screen saver image or reduce screen brightness by entering the manager password. To set up a customised screen saver, contact your distributor.
	If you opted for installation with “identity check” configuration

Training – Installing a wine bottle

❁ Installing at least one wine bottle

Check the condition of the bottle neck before inserting the bottle. There must be no residue on the top of the bottle.



From the welcome screen, access the **Settings menu**

Then select

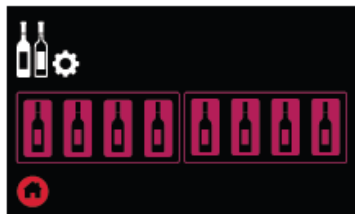

Select the bottle that you want to set



Select the pictogram on the right

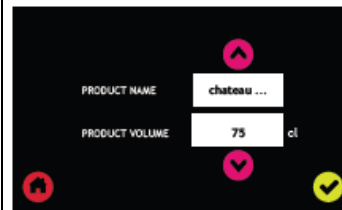

Indicate the name of the label and the volume of the bottle that you are placing in the appliance using the keyboard on the screen.

Then confirm

Repeat this procedure for the other bottles.

Place the bottle → Show the gesture and have the client practice.

❁ Show the possible locations for Magnums bottles

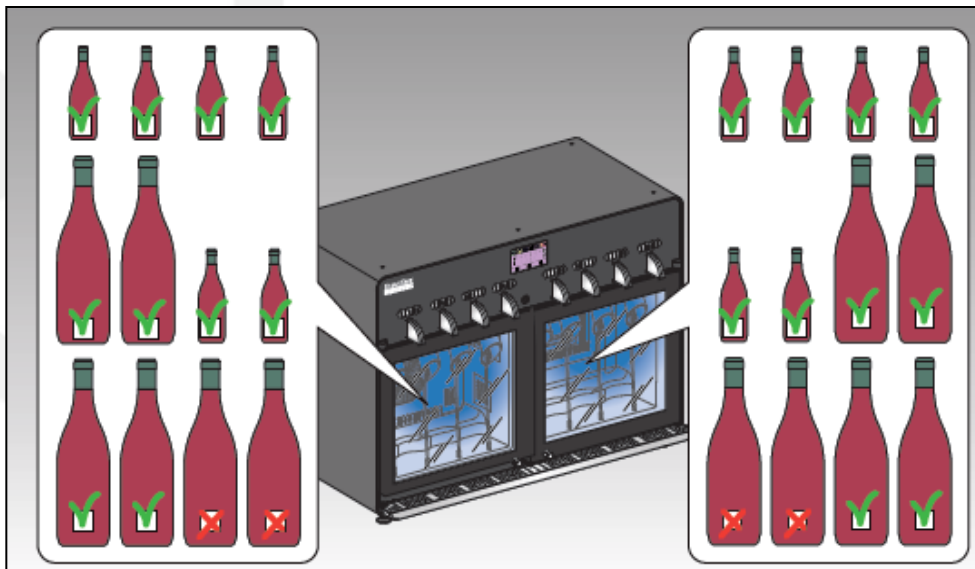

Training – Installing a wine bottle

❁ Explain the right position of articulated head

! *Important* : the articulated head must remain in an inclined position. If it is vertical without a bottle, it will cause nitrogen to leak (Diagram A).

💡 *Tips* : if there is no bottle in the bottle holder, you can clip the plunge tube inside the articulated head. This prevents the plunge tube from touching the door (Diagram B).

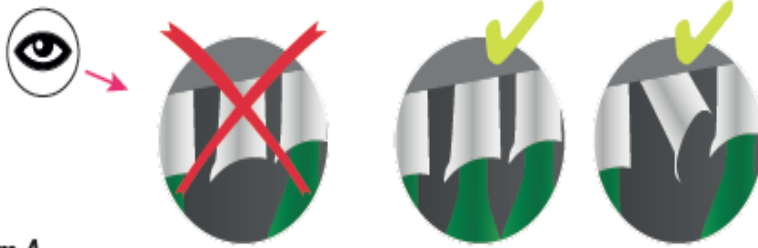

Diagram A

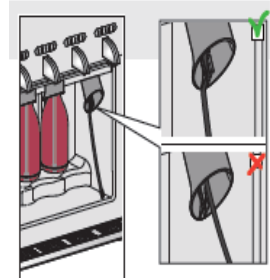

Diagram B

❁ Explain the meaning of the label which is stuck on the articulated head

This label is present on one of the articulated heads of each compartment.

If a bottle is having problems staying in place inside the articulated head, the neck or the seal are perhaps too damp.

➔ Dry the seal and the neck then try again.

The labels are repositionable and can easily be removed once the users are trained.

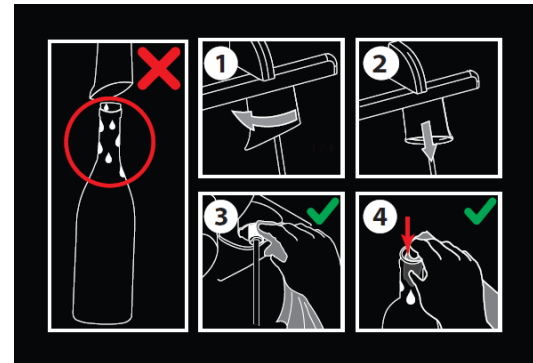

Training – Serving a measure

❁ Serving a measure



DO NOT USE THE « MANUAL » MODE to serve a measure.
This step is no longer necessary with this product unlike the former VOV3.

If you place the 8 bottles with the client... And if ...

- The next service is within a couple of hours

Serve a measure for each bottle to get the oxygen out.

To do so, you don't need to switch to manual mode but just serve a measure of 1cl on each bottle for example.

- The next service is the day after

Serve a measure (to evacuate oxygen), then do an automatic cleaning (daily cleaning) to prevent oxidation of the remaining wine in the taps

❁ Delivery of keys & accessories



19	Graduated measuring cylinder
20	Cleaning bottle
21	2 glass holders
22	Set of 2 keys
23	Keyring
24	White marker pen
25	4mm Allen key
26	Pressure reducer
27	Nitrogen cylinder (not supplied)
28	Plunge tube filter/strainer
29	Pressure reducer wrench

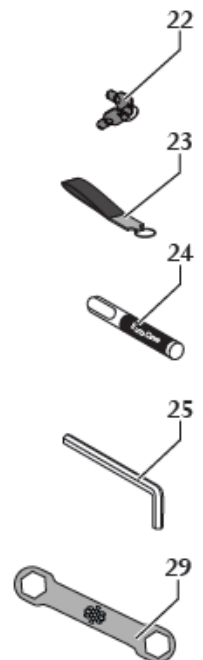

Training – Operating faults and warning messages

REMINDERS



This indicator light will flash every 24H to remind you to carry out cleaning if the product has been used.



Explain to the customer that the level of remaining gas in the nitrogen bottle can be seen on the pressure manometer to anticipate the replenishment.

A notification  appears on the screen every 2 weeks remind the user to check the remaining nitrogen level.

WARNING MESSAGES

Remind the client that each **warning message** is associated to a **tutorial** that must be followed to solve the issue.

Possibility to simulate a leak or empty nitrogen bottle to make a demonstration.

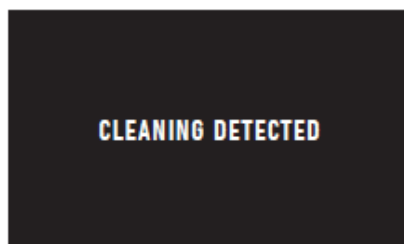
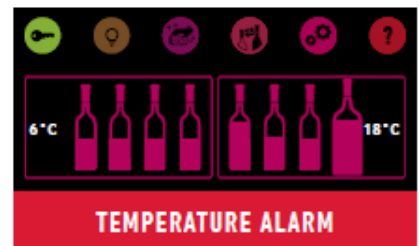

These elements with the resolutions are detailed on the technical manual

Training - Maintenance procedures

MAINTENANCE PROGRAM

- ❁ Remind the client that a maintenance program (specify duration) is planned with operations **every 6 months**
- ❁ Specify that an orange wrench will appear on the screen as a reminder for the maintenance.



DAILY CLEANING

- ❁ If you demonstrate it to the client, do it after placing the bottles and serving measures of 1 cl for each bottles.

It is important to clean the tap circuit to maintain your Vin au Verre 8.0 in good working order and to retain all of the flavours of your wine. The **Daily cleaning**  indicator light flashes every 24 hrs to remind you, unless the product has not been used. The following process allows simultaneous cleaning of all 8 taps, **and does not require you to move or remove bottles from the appliance.**

1 From the welcome screen, select 

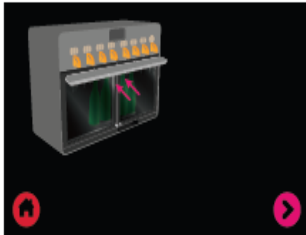
2  Place the drip pan in the upper position.
To do so, lift and tilt the drip pan upwards to remove it, and place it in the upper position by following the instructions on the screen.

The tabs of the drip tray must fit into the slots located above the doors so that the drip pan is pushed against the doors to the maximum.

3  Retrieve the cleaning tube from the hole located at the back of the drip tray, when this is in the lower position.
Insert this tube into the cleaning bottle filled with clean water.

Confirm  when this is done.
Cleaning is carried out automatically.

4 Once completed, empty the contents of the drip pan into a sink, put the tube in its original location and replace the drip pan by tilting it forwards.

 If you lose the cleaning bottle, use a container with a volume of 250 ml (a glass of water, for example)
A container with a volume greater than 500 ml might cause the rinse water to overflow from the drip pan.

Training - Maintenance procedures

MONTHLY CLEANING (see Quickstart.)

